

ENERGIZER 522

9V

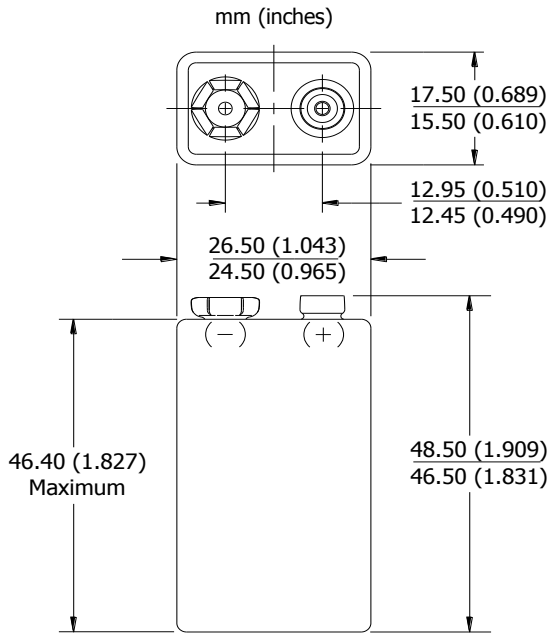

Industry Standard Dimensions



Specifications

Classification:	Alkaline
Chemical System:	Zinc-Manganese Dioxide (Zn/MnO ₂) No added mercury or cadmium
Designation:	ANSI-1604A, IEC-6LR61
Nominal Voltage:	9.0 volts
Operating Temp:	-18°C to 55°C (0°F to 130°F)
Typical Weight:	45.6 grams (1.6 oz.)
Typical Volume:	21.1 cubic centimeters (1.3 cubic inch)
Jacket:	Metal
Shelf Life:	5 years at 21°C
Terminal:	Miniature Snap

Milliamp-Hours Capacity

Continuous discharge to 4.8 volts at 21°C

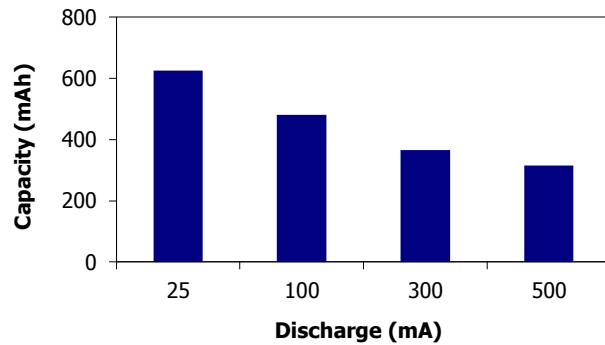

Device Selection Guide:

Battery Selection Indicator

- Toy 
- Baby Monitor 
- Garage Opener 
- Clock Radio 
- Smoke Detector 



Important Notice

This datasheet contains typical information specific to products manufactured at the time of its publication.
©Energizer Holdings, Inc. - Contents herein do not constitute a warranty.

ENERGIZER 522

9V

Constant Resistance Performance
Typical Characteristics (21°C)

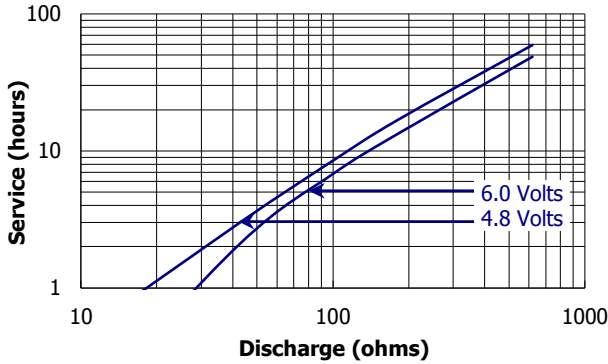

Constant Current Performance
Typical Characteristics (21°C)

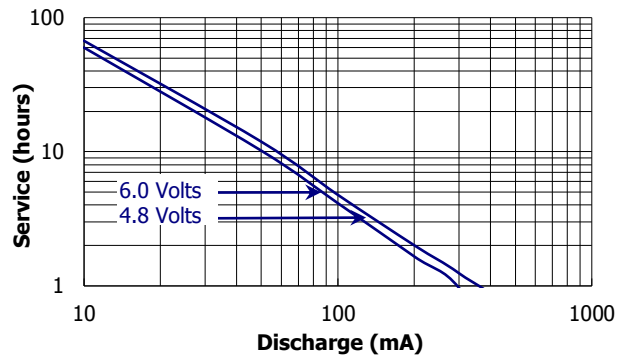

Industry Standard Tests (21°C)

RADIO
620 ohm 2 hrs/day

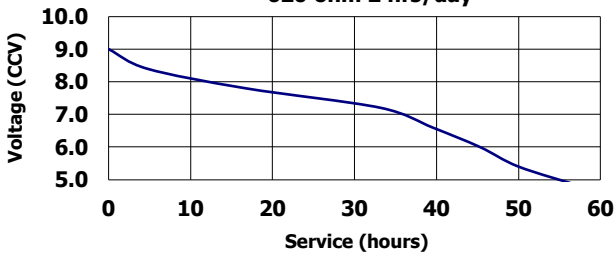

TOY
270 ohm 1 hr/day

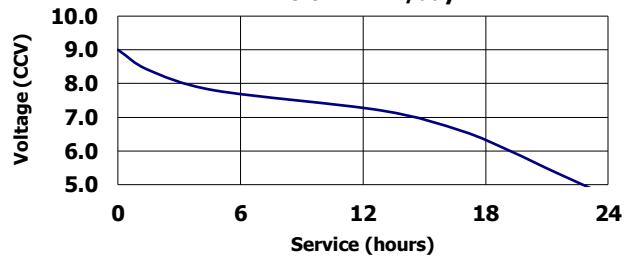

ACCELERATED SMOKE DETECTOR
10K/620 ohm 1 sec/hr pulse

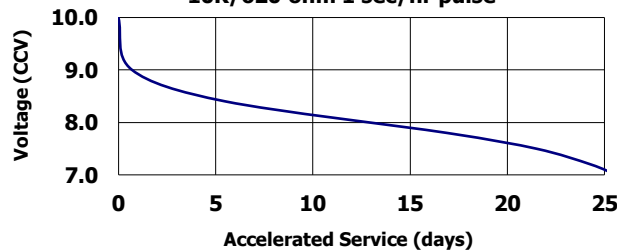

Important Notice

This datasheet contains typical information specific to products manufactured at the time of its publication.
©Energizer Holdings, Inc. - Contents herein do not constitute a warranty.