

ENERGIZER MAX

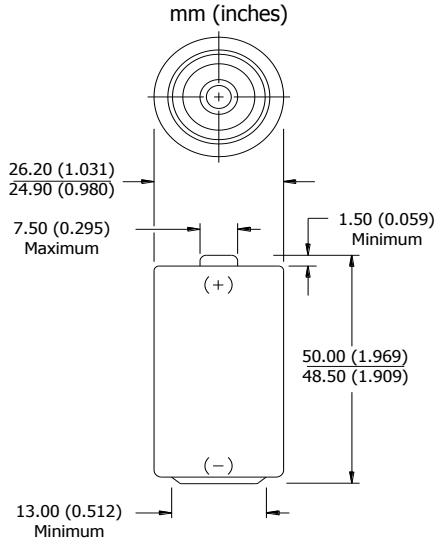

Industry Standard Dimensions



Specifications



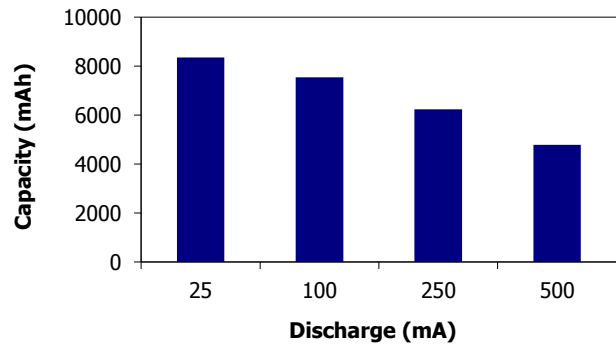

Classification:	Alkaline
Chemical System:	Zinc-Manganese Dioxide (Zn/MnO ₂) No added mercury or cadmium
Designation:	ANSI-14A, IEC-LR14
Nominal Voltage:	1.5 volts
Nominal IR:	150 to 300 milliohms (fresh)
Operating Temp:	-18°C to 55°C (0°F to 130°F)
Typical Weight:	66.2 grams (2.3 oz.)
Typical Volume:	26.9 cubic centimeters (1.6 cubic inch)
Jacket:	Plastic Label
Shelf Life:	10 years at 21°C
Terminal:	Flat Contact

Milliamp-Hours Capacity

Continuous discharge to 0.8 volts at 21°C



Device Selection Guide:

- Portable Stereo 
- Toy 
- Lighting 
- Radio 

Battery Selection Indicator

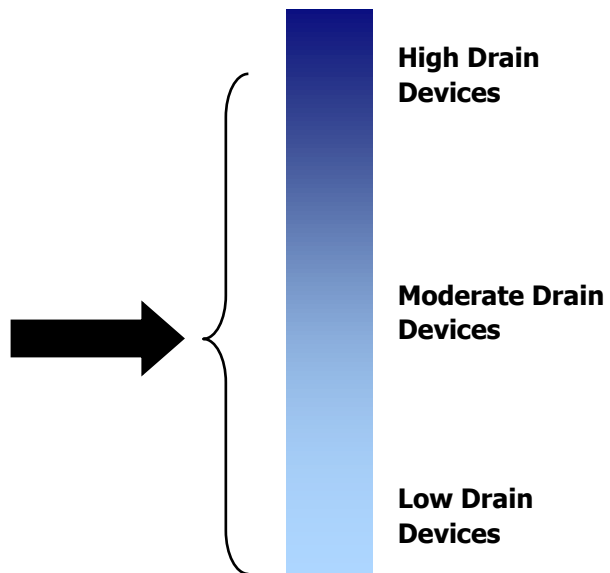

Important Notice

This data sheet contains typical information specific to products manufactured at the time of its publication.
©Energizer Holdings, Inc. - Contents herein do not constitute a warranty.

ENERGIZER E93



Constant Resistance Performance
Typical Characteristics (21°C)

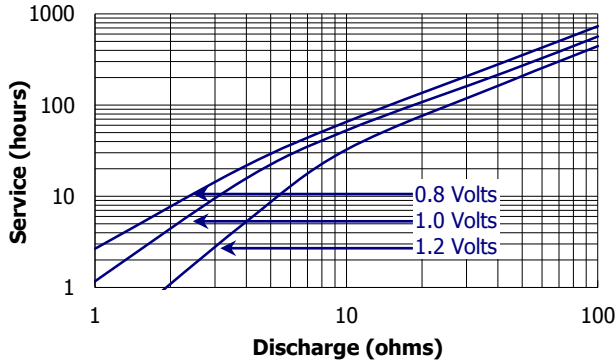

Constant Current Performance
Typical Characteristics (21°C)

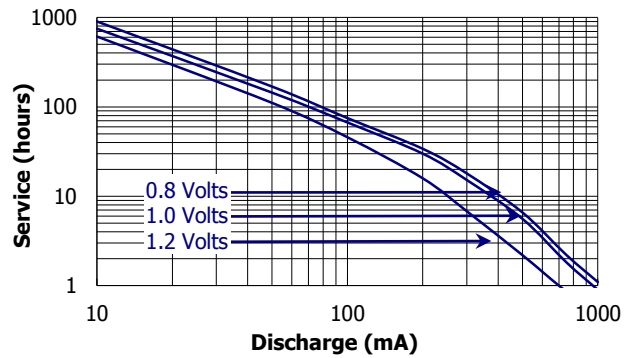

Industry Standard Tests (21°C)

RADIO
20 ohm 4 hrs/day

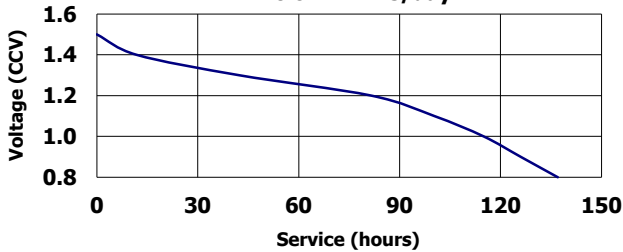

LIGHTING
3.9 ohm LIF

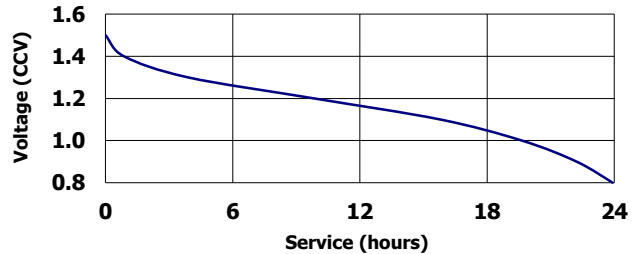

TOY
3.9 ohm 1 hr/day

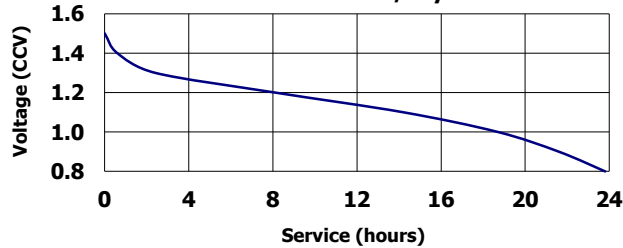

PORTABLE STEREO
400 mA 2 hrs/day

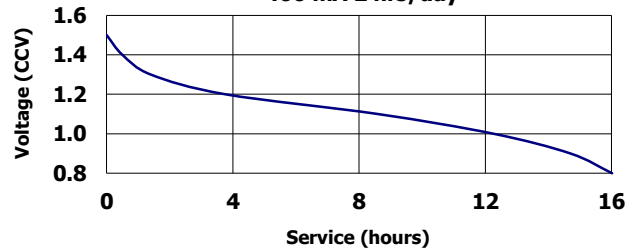

Important Notice

This data sheet contains typical information specific to products manufactured at the time of its publication.
©Energizer Holdings, Inc. - Contents herein do not constitute a warranty.