

LongLast™

Biax™ D and D/E

Compact Fluorescent Lamps Non-Integrated
10W, 13W, 18W and 26W

DATA SHEET

Product information

Biax™ D & D/E LongLast™ lamps are available in 10, 13, 18 and 26 watt ratings, 10 and 13W in T3 tube size, 18 and 26W in T4 tube size and ranging from 101mm to 174mm in length. Five colours are available in two-pin and four-pin caps. A high colour rendering index (CRI) of 82 gives rich, vibrant colour. The lamps are available in warm and cool colour temperatures suitable for a wide variety of environments.



Features

- Up to 80% energy saving versus normal incandescent lamps
- Lasts 10 times longer than standard incandescent lamps
- High colour rendering index – 82Ra
- Full range of colour temperatures – 2700, 3000, 3500, 4000 and 6500K
- 4-pin lamps for use with electronic gear may be used with dimmers

Application Areas:



Hospitality



Retail



GE imagination at work

Basic data

Nominal Wattage [W]	Rated Wattage on Standard Gear [W]	Energy consumption [kWh/1000h]	Voltson Standard Gear [V]	Cap	Product Description	Product Code	Nominal Lumen [lm]	Rated Lumen [lm]	Rated Lamp Efficacy on Standard Gear [lm/W]	CCT [K]	CRI [Ra]	Mercury [mg]	Life on Standard Gear 3h-cycle [h]	Diameter [mm]	Length [mm]	EEC	PackQty
Biax™ D 2-pin, Internal Starter																	
10	10	12.70	64	G24d-1	F10DBX/T3/827/2P	78211	600	600	60	2700	82	1.3	12,000	34,4	108	B	10
10	10	12.70	64	G24d-1	F10DBX/T3/830/2P	78212	600	600	60	3000	82	1.3	12,000	34,4	108	B	10
10	10	12.70	64	G24d-1	F10DBX/T3/835/2P	78213	600	600	60	3500	82	1.3	12,000	34,4	108	B	10
10	10	12.70	64	G24d-1	F10DBX/T3/840/2P	78214	600	600	60	4000	82	1.3	12,000	34,4	108	B	10
10	10	12.70	64	G24d-1	F10DBX/T3/865/2P	78215	600	600	60	6500	82	1.3	12,000	34,4	108	B	10
13	13	16.18	91	G24d-1	F13DBX/T3/827/2P	78221	900	900	69	2700	82	1.3	12,000	34,4	139	A	10
13	13	16.18	91	G24d-1	F13DBX/T3/830/2P	78222	900	900	69	3000	82	1.3	12,000	34,4	139	A	10
13	13	16.18	91	G24d-1	F13DBX/T3/835/2P	78223	900	900	69	3500	82	1.3	12,000	34,4	139	A	10
13	13	16.18	91	G24d-1	F13DBX/T3/840/2P	78224	900	900	69	4000	82	1.3	12,000	34,4	139	A	10
13	13	16.18	91	G24d-1	F13DBX/T3/865/2P	78225	900	900	69	6500	82	1.3	12,000	34,4	139	A	10
18	18	22.10	100	G24d-2	F18DBXT4/SPX27/827	12860	1200	1200	67	2700	82	1.3	12,000	34,4	154	B	10
18	18	22.10	100	G24d-2	F18DBXT4/SPX30/830	12861	1200	1200	67	3000	82	1.3	12,000	34,4	154	B	10
18	18	22.10	100	G24d-2	F18DBXT4/SPX35/835	12863	1200	1200	67	3500	82	1.3	12,000	34,4	154	B	10
18	18	22.10	100	G24d-2	F18DBXT4/SPX41/840	12864	1200	1200	67	4000	82	1.3	12,000	34,4	154	B	10
18	18	22.10	100	G24d-2	F18DBXT4/SPX65/865	13017	1200	1200	67	6500	82	1.3	12,000	34,4	154	B	10
26	26	31.35	105	G24d-3	F26DBXT4/SPX27/827	35250	1800	1800	69	2700	82	1.3	12,000	34,4	169.5	B	10
26	26	31.35	105	G24d-3	F26DBXT4/SPX30/830	35237	1800	1800	69	3000	82	1.3	12,000	34,4	169.5	B	10
26	26	31.35	105	G24d-3	F26DBXT4/SPX35/835	35251	1800	1800	69	3500	82	1.3	12,000	34,4	169.5	B	10
26	26	31.35	105	G24d-3	F26DBXT4/SPX41/840	35252	1800	1800	69	4000	82	1.3	12,000	34,4	169.5	B	10
26	26	31.42	105	G24d-3	F26DBXT4/SPX65/865	35305	1710	1710	66	6500	82	1.3	12,000	34,4	169.5	B	10

Nominal Wattage [W]	Rated Wattage on Standard Gear [W]	Energy consumption [kWh/1000h]	Voltson Standard Gear [V]	Cap	Product Description	Product Code	Nominal Lumen [lm]	Rated Lumen [lm]	Rated Lamp Efficacy on Standard Gear [lm/W]	CCT [K]	CRI [Ra]	Mercury [mg]	Life on electronic gear 12h-cycle [h]	Diameter [mm]	Length [mm]	EEC	PackQty
Biax™ D/E LongLast™ 4-pin, External Starter Required																	
10	10	10.45	64	G24q-1	F10DBX/T3/827/4P	78217	600	600	60	2700	82	1.3	20,000	34,4	100.5	A	10
10	10	10.45	64	G24q-1	F10DBX/T3/830/4P	78218	600	600	60	3000	82	1.3	20,000	34,4	100.5	A	10
10	10	10.45	64	G24q-1	F10DBX/T3/835/4P	78219	600	600	60	3500	82	1.3	20,000	34,4	100.5	A	10
10	10	10.45	64	G24q-1	F10DBX/T3/840/4P	78220	600	600	60	4000	82	1.3	20,000	34,4	100.5	A	10
10	10	10.45	64	G24q-1	F10DBX/T3/865/4P	78231	600	600	60	6500	82	1.3	20,000	34,4	100.5	A	10
13	13	13.75	91	G24q-1	F13DBX/T3/827/4P	78226	900	900	69	2700	82	1.3	20,000	34,4	131.5	A	10
13	13	13.75	91	G24q-1	F13DBX/T3/830/4P	78227	900	900	69	3000	82	1.3	20,000	34,4	131.5	A	10
13	13	13.75	91	G24q-1	F13DBX/T3/835/4P	78228	900	900	69	3500	82	1.3	20,000	34,4	131.5	A	10
13	13	13.75	91	G24q-1	F13DBX/T3/840/4P	78229	900	900	69	4000	82	1.3	20,000	34,4	131.5	A	10
13	13	13.75	91	G24q-1	F13DBX/T3/865/4P	78232	900	900	69	6500	82	1.3	20,000	34,4	131.5	A	10
18	18	18.15	100	G24q-2	F18DBX/SPX27/827/4P	12865	1200	1200	67	2700	82	1.3	20,000	34,4	146.5	A	10
18	18	18.15	100	G24q-2	F18DBX/SPX30/830/4P	12866	1200	1200	67	3000	82	1.3	20,000	34,4	146.5	A	10
18	18	18.15	100	G24q-2	F18DBX/SPX35/835/4P	12869	1200	1200	67	3500	82	1.3	20,000	34,4	146.5	A	10
18	18	18.15	100	G24q-2	F18DBX/SPX41/840/4P	12870	1200	1200	67	4000	82	1.3	20,000	34,4	146.5	A	10
26	26	26.40	105	G24q-3	F26DBX/SPX27/827/4P	35247	1800	1800	69	2700	82	1.3	20,000	34,4	162	A	10
26	26	26.40	105	G24q-3	F26DBX/SPX30/830/4P	35235	1800	1800	69	3000	82	1.3	20,000	34,4	162	A	10
26	26	26.40	105	G24q-3	F26DBX/SPX35/835/4P	35248	1800	1800	69	3500	82	1.3	20,000	34,4	162	A	10
26	26	26.40	105	G24q-3	F26DBX/SPX41/840/4P	35236	1800	1800	69	4000	82	1.3	20,000	34,4	162	A	10
26	26	26.40	105	G24q-3	F26DBX/SPX65/865/4P	42798	1710	1710	66	6500	82	1.3	20,000	34,4	162	A	10

Biax™ D/E LongLast™ 4-pin average life with Standard Gear on 3 hours per start is 12,000 hours.

Dimensions

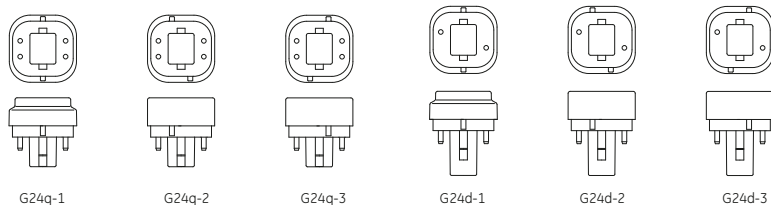
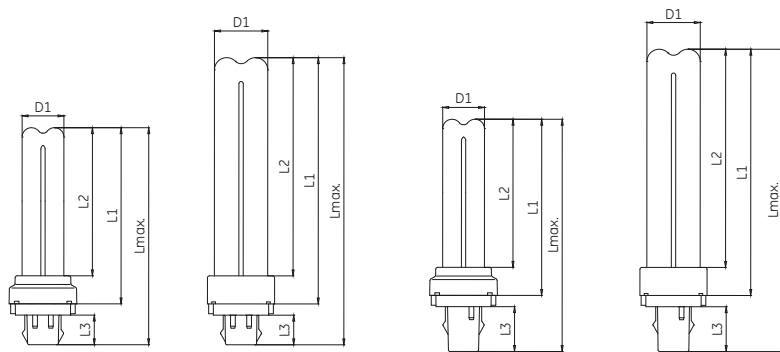

Nominal Wattage [W]	L1 [mm]	L2 [mm]	L3 [mm]	Lmax [mm]	D1 [mm]
Biax™ D 2-pin					
10	78.7	64.5	22.4	108	21.5
13	109.7	95.5	22.4	139	21.5
18	124.7	110.5	22.4	154	27
26	140.2	126	22.4	169.5	27
Biax™ D/E LongLast™ 4-pin					
10	78.7	91.2	15	100.5	21.5
13	109.7	95.5	15	131.5	21.5
18	124.7	110.5	15	146.5	27
26	140.2	126	15	162	27

Lamp life

Rated average life for Biax™ D LongLast™ is 12,000 hours (switching cycle: 2hrs 45min ON/15min OFF, see Graph A) and D/E LongLast™ is 20,000 hours (switching cycle: 11hrs ON/1hrs OFF, see graph B).

Cathodes of a fluorescent lamp lose their electron-emissivity during life due to the evaporation of emission mixture. When the deterioration reaches a certain level, the cathode breaks. Typical lifetime characteristics are based on GE Lighting's measurements according to the relevant IEC standards. The declared lamp life is the median life, which is when 50% of the lamps from a large sample batch would have failed. Real lifetime figures may depend on actual application. For instance improper cathode preheat, too high operating current, or too low operating current without additional cathode heating reduces the expected life.

Lumen maintenance

Lumen maintenance graph shows how the luminous output decreases throughout life. The main causes of the light depreciation are the deterioration of phosphor coating and the lamp blackening due to the deposition of evaporated emission mixture on the glass tube. These effects are unavoidable. Lumen maintenance curve presented here for Biax™ D and D/E LongLast™ lamps are based on lumen readings under laboratory conditions.

Test conditions:

- Photometric sphere
- Vertical, cap up burning position
- Switching cycle: 11 hours On – 1 hour Off
- High frequency operation 25°C ambient temperature

See graph A and B.

Life versus frequency of switching

For impact on life of alternative switching cycles refer to the Graph C. For applications where a fast switching cycle is required it is possible to minimise the effect of switching on lamp life with the use of a suitable electronic gear with a 4-pin lamp.

Biax™ D on standard gear

Graph A

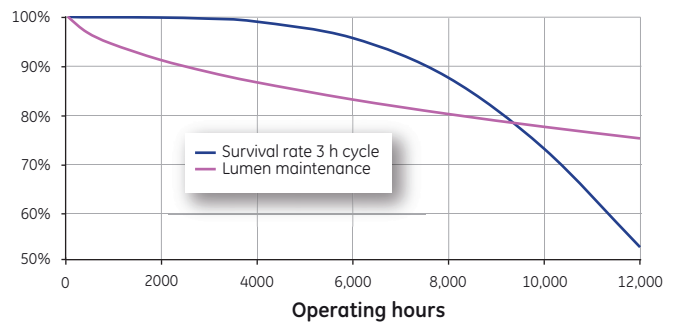

Hours	Survival rate 3h cycle	Lumen maintenance
100	1.00	1.00
500	1.00	0.97
1000	1.00	0.95
2000	1.00	0.91
3000	1.00	0.89
4000	0.99	0.87
6000	0.96	0.83
8000	0.88	0.80
10000	0.73	0.77
12000	0.53	0.75

Biax™ D/E on electronic gear

Graph B

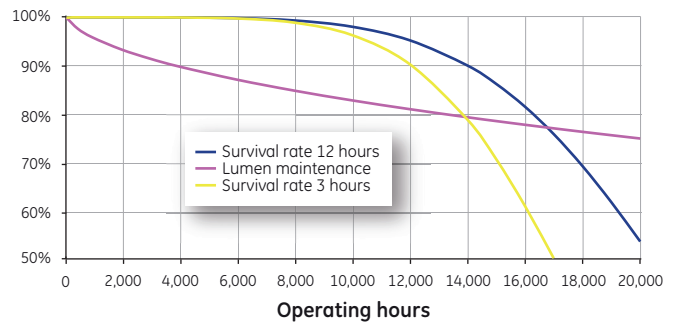

Hours	Survival rate 12 hours	Lumen maintenance	Survival rate 3 hours
2,000	1.00	0.93	1.00
4,000	1.00	0.89	1.00
8,000	1.00	0.84	0.99
12,000	0.96	0.80	0.90
16,000	0.83	0.78	0.61
20,000	0.53	0.75	

Life versus frequency of switching

Graph C

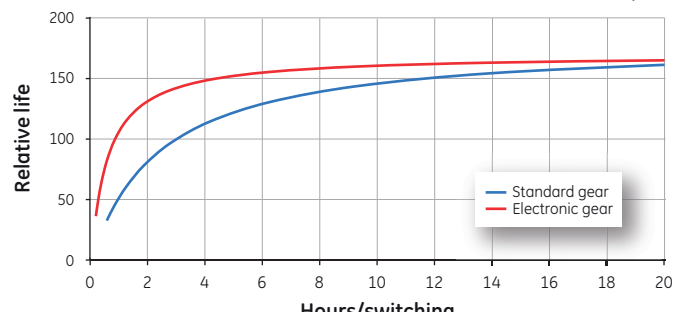

Luminous intensity distribution

The luminous intensity distribution describes the quantity of light that is radiated in a particular direction.

Graph D shows luminous intensity distribution curve of Biax™ D & D/E lamps. Tests were taken with lamps burning in vertical cap up position. The left plot of Graph D shows horizontal while the right plot shows the vertical light intensity distribution plots.

Radial luminous intensity distribution (horizontal)

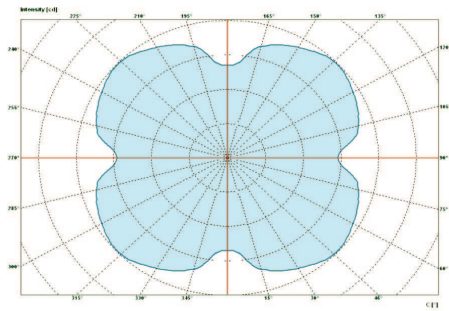

Graph D

Radial luminous intensity distribution (vertical)

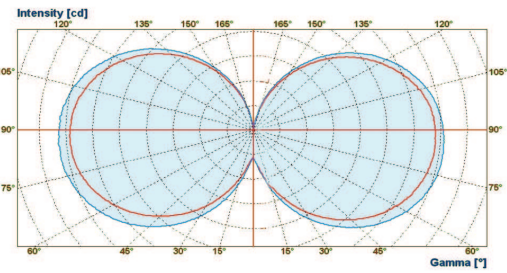

Burning position: cap up

Graph D

Lumen output vs. ambient air temperature

Photometrical and light parameters of a fluorescent lamp depend on the mercury vapor pressure inside the lamp. Mercury vapor pressure in turn is controlled by temperature. When installed in a luminaire, the temperature of the air surrounding the lamp cap changes and this can affect the light output of the lamp. The effects of changes in ambient temperature for a typical lamp are shown in Graph E.

Light output of DBX lamps vs ambient temperature vertical base up burning position

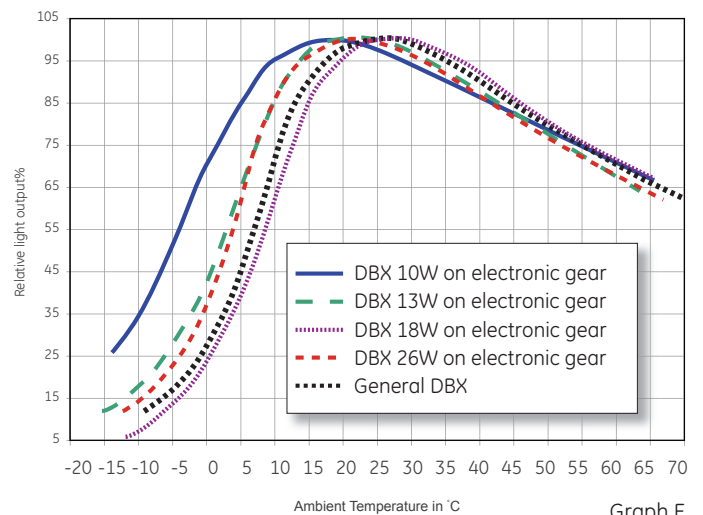

Graph E

Spectral distribution

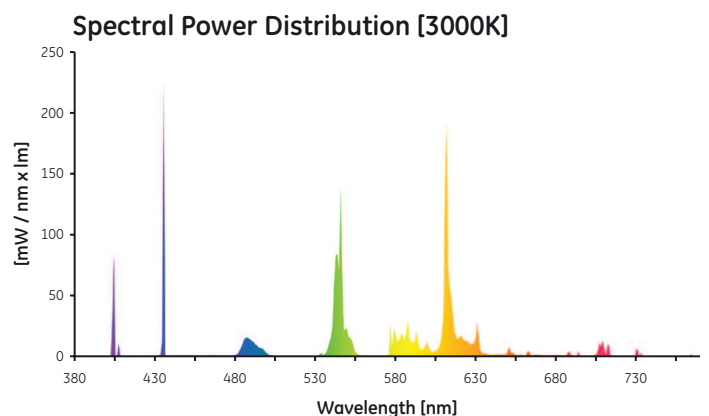
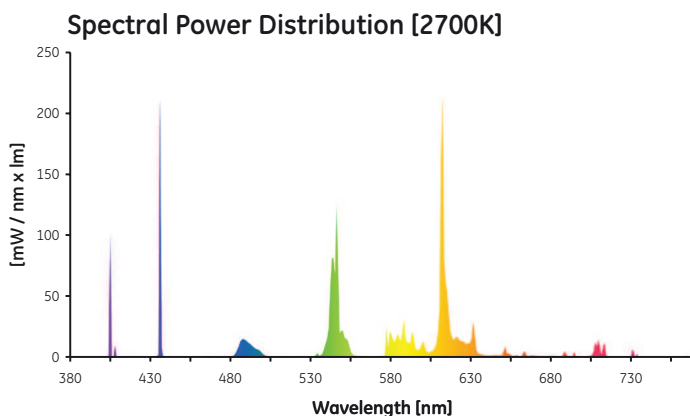

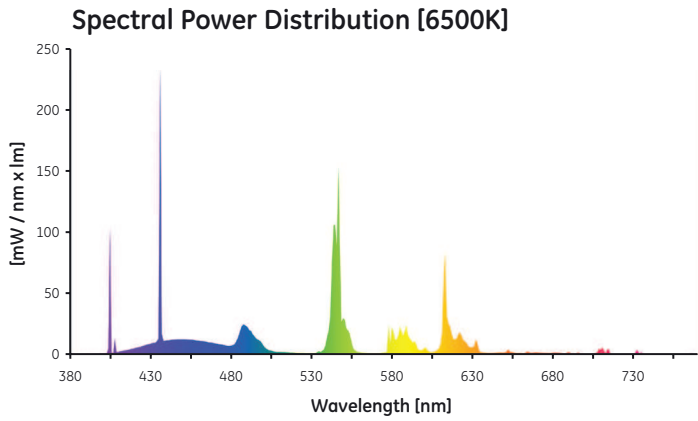
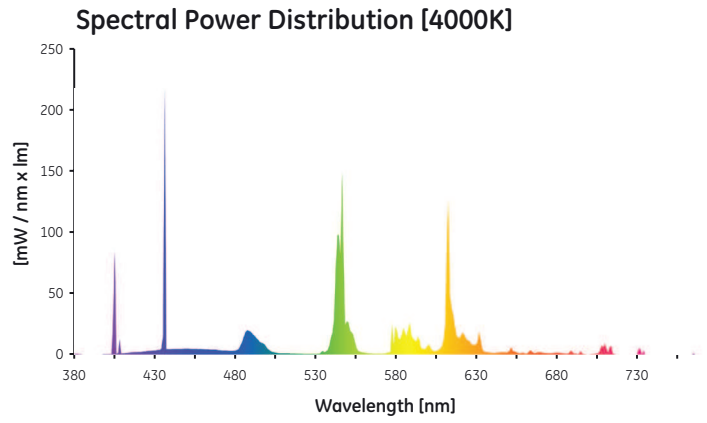
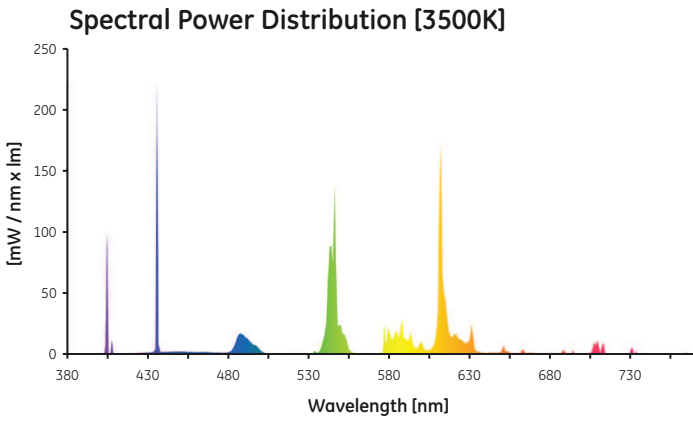

Biax™ D/E compatibility with other 4pin cap lamps

Biax™ D Compatibility with Biax™ T 2pin Cap Lamps				Biax™ D Compatibility with Biax™ T 4pin Cap Lamps					
2pin Biax™ D (Double)		2pin Biax™ T (Triple)		4pin Biax™ D (Double)		4pin Biax™ T (Triple)			
		F13TBX	F18TBX			F26TBX	F13TBX/4P	F18TBX/4P	F26TBX/4P
		Gx24d-1	Gx24d-2	Gx24d-3			Gx24q-1	Gx24q-2	Gx24q-3
F10DBX	G24d-1	yes			F10DBX/4P	G24q-1	yes		
F13DBX	G24d-1	yes			F13DBX/4P	G24q-1	yes		
F18DBX	G24d-2	yes			F18DBX/4P	G24q-2	yes		
F26DBX	G24d-3	yes			F26DBX/4P	G24q-3	yes		

Circuit diagrams

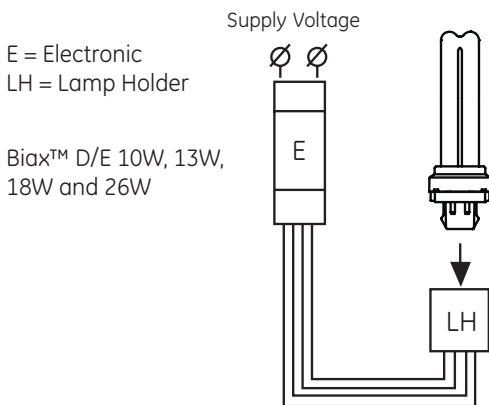

Parallel Compensated

B = Ballast (50Hz)
LH = Lamp Holder

Biax™ D 10W, 13W, 18W and 26W

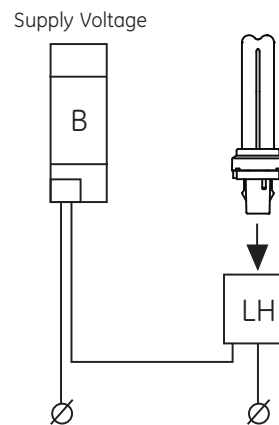

Light colour applications

Warm; Warm White 2700 K

Specialty retailers, restaurants, hotel lobbies, residential applications

Neutral; Neutral White 3000-3500 K

Grocery stores & produce markets, retail stores, bank lobbies

Cool; Cool White 4000 K

Offices, manufacturing, schools, hospitals

Daylight 6500 K

Printers, paint studios, art galleries, car dealerships

Gear specification

Cathode resistances

Nominal Power	Cap	Standard Datasheet 60901-IEC	Test current [A]	Cathode resistance @ Itest		
				Rated [ohm]	Min. [ohm]	Max. [ohm]
10	G24q-1	-2510	0.1	50	37.5	62.5
13	G24q-1	-2513	0.1	50	37.5	62.5
18	G24q-2	-2518	0.2	26	19.5	32.5
26	G24q-3	-2526	0.3	13	9.7	16.3

Resistance values measured a test current
Values conform IEC 60901 related datasheets

Cathode preheat requirements

Nominal Power	Cap	Standard Datasheet 60901-IEC	Emin = Qmin + Pmin*ts			Emax = Qmax + Pmax*ts		
			Qmin [J]	Pmin [W]	Rsub,min [ohm]	Qmax [J]	Pmax [W]	Rsub,max [ohm]
10	G24q-1	-2510	1	0.6	30	2	1.2	40
13	G24q-1	-2513	1	0.7	30	2	1.4	40
18	G24q-2	-2518	0.9	0.7	18	1.8	1.4	24
26	G24q-3	-2526	1	0.8	9	2	1.6	12

Preheat time shall be longer than 0.4s and shorter than 3s
Ballast preheat energy shall be measured with substitution resistance of above table
Values conform IEC 60901 related datasheets

Dimming requirements

Nominal Power	Cap	Standard Datasheet 60901-IEC	Idmin [A]	Idmax [A]	X [A2]	Y [A]
10	G24q-1	-2510	0.015	0.115	0.035	0.26
13	G24q-1	-2513	0.015	0.115	0.035	0.26
18	G24q-2	-2518	0.02	0.16	0.07	0.35
26	G24q-3	-2526	0.03	0.25	0.175	0.57

In the dimming range of the lamp operating current Idmin – Idmax
Minimum SoS = $ILH2+ILL2=X*Y*Id$
Target SoS = $ILH2+ILL2=X*0.3*Y*Id$
Idmax for dimming operation = Idmin for normal operation
Values conform IEC proposal

When the new fluorescent lamp is installed into dimming system, it is advised to operate lamps for period of 100 hours at full light output.

Starting requirements

Nominal Power	Cap	Standard Datasheet 60901-IEC	Ignition voltage [Vrms]	Non-ignition voltage [Vrms]	Rsub [ohm]
10	G24q-1	-2510	340	180	30...90
13	G24q-1	-2513	380	190	30...90
18	G24q-2	-2518	400	220	18...54
26	G24q-3	-2526	420	240	9...27

Ballast open circuit voltage shall be measured with substitution resistance of above table
Values conform IEC 60901 related datasheets

Recommended list of ballasts*

	Wattage	Lamp description	Ballast manufacturer	Single ballast description	Twin ballast description
Biax™ D/E LongLast™ 4-pin	10W	F10DBX/SPX27/827/4P	Tridonic Atco Helvar Vossloh-Schwabe	PC 1x10-13 TCD PRO EL 1/2x9-13TCs ELXc.113.402	PC 2/10/13 TCD PRO EL 1/2x9-13TCs
Biax™ D/E LongLast™ 4-pin	13W	F13DBX/SPX27/827/4P	Tridonic Atco Helvar Vossloh-Schwabe	PC 1x5-16 W Basic EL 1/2x9-13TCs ELXc.113.402	PC 2/10/13 TCD PRO EL 1/2x9-13TCs
Biax™ D/E LongLast™ 4-pin	18W	F18DBX/SPX27/827/4P	Tridonic Atco Helvar Vossloh-Schwabe	PC 1x18 TCD PRO EL1/2x18TCs ELXc.118.831	PC 2/18 TCD PRO EL1/2x18TCs
Biax™ D/E LongLast™ 4-pin	26W	F26DBX/SPX27/827/4P	Tridonic Atco Helvar Vossloh-Schwabe	PC 1x26/32/42 TCT PRO EL 1/2x18-42TCs ELXc.142.872	PC 2x26/32 TCT PRO EL 1/2x18-42TCs ELXc.257.836

*Ballast manufacturers have the right to change ballast specification without prior notification or official announcement so these data based on GE measurement 2010/2011.

Compliance

Standards

IEC 60061-1	Lamp caps and holders together with gauges for the control of interchangeability and safety
IEC or EN 60901	Single-capped lamps - performance requirements
IEC or EN 61199	Single-capped lamps - safety requirements
CIE S 009/E:2002	Photobiological safety of lamps and lamp systems

European Directives

CE mark	93/68/EEC; LVD: 2006/95/EC; Ecodesign 2005/32/EC, ROHS 2011/65/EU
Energy Labelling	Directive 2010/30/EU, 874/2012/EU energy labelling of electrical lamps and luminaires
RoHS	Directive 2011/65/EU on Restrictions of the use of certain Hazardous Substances (RoHS)
WEEE	Directive 2012/19/EU on Waste Electrical and Electronic Equipment (WEEE)
REACH	Directive 2006/1907/EC on Registration, Evaluation, Authorisation and Restriction of Chemicals (REACH)
ErP ecodesign	Directive 2005/32/EC, 2009/245/EC ecodesign requirements (of Energy-related Products) for tertiary sector lamps
